

Article number: 03554050

Description: Fluro hydraulic rod end FMA 50D

## Measures

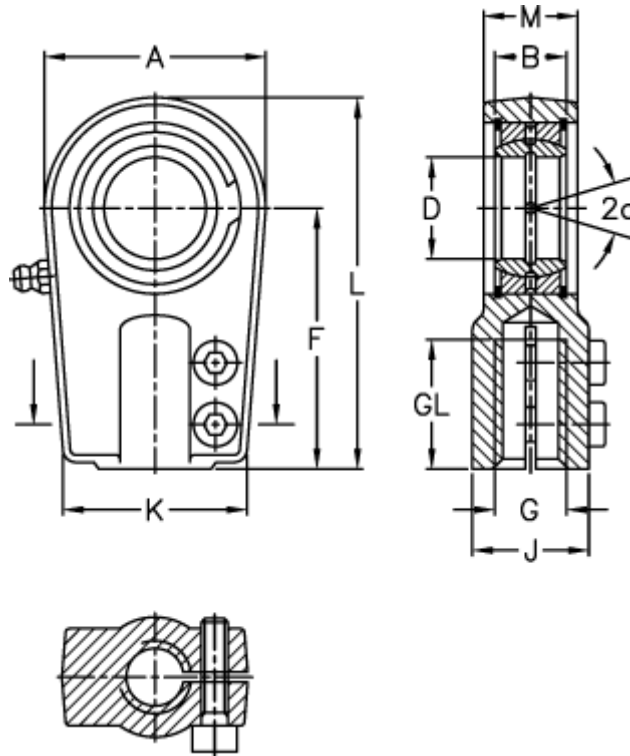

A	= 116	J	= 70
a (degrees)	= 7	K	= 90
B	= 35	L	= 198
D	= 50	M	= 40
Dynamic load C (kN)	= 220	Static load C0 (kN)	= 442
F	= 135	Torque (N m)	= 80
g	= M50x3	Weight	= 4100
GL	= 75		